

Operating Instructions



GRASSLIN

A GE Industrial Systems Company

Digi 42 Series One Circuit Electronic 24 Hour or 7 Day Time Switches



Digi 42A
(surface mounting)



Digi 42E
(flush mounting)

APPLICATION

Time based control of lighting, ventilating, heating, cooling or other electrical loads in commercial and industrial applications. The Digi 42 time switches are programmable for 24-hour or 7-day schedules as well as a "8th day" or holiday schedule.

The Digi 42A series is intended for either surface or DIN rail mounting. The control is completely enclosed in a plastic housing and includes a terminal cover and sub-base for installation and hard wiring.

The Digi 42E is intended for flush (panel) mounting.

Both models are supplied with a clear plastic snap-on dust cover.

TECHNICAL DATA

Output – SPDT relay with dry contacts

Switch Rating: 16A/277VAC resistive

1000W tungsten @ 240VAC; 500W @ 120VAC

1/2 hp @ 120VAC; 1 hp @ 240VAC

7 day battery back-up

Supply voltages: Separate Models – 12VDC, 24VAC/DC, 120VAC, 208/240VAC, all 50/60Hz (refer to product label)

Shortest switch time: 1 minute

Ambient Temperature Range –20°F to 140°F (–28°C to 60°C)

AM/PM LCD display

Input Draw: 120V & 240V models: 4VA

24V model: 2VA @ 24VAC, 1VA @ 24VDC

Screw terminal connections (Digi 42A)

1/4" quick connects (Digi 42E)

Accuracy ± 4 minutes per year

Installation

To the installer:

1. Read operating instructions carefully.
2. Check the input and output ratings marked on the unit to make sure this product is suitable for your power supply and application.
3. Disconnect power supply prior to installation to prevent electrical shock.
4. Wire in accordance with National and Local electrical code requirements.

The Digi 42 time switches are available with an enclosure for stand-alone applications (GM digi 42 and GMX digi 42 models).

SURFACE MOUNTING—Digi 42A

Remove cover, loosen two screws on opposite corners. Remove the housing that surrounds the time switch and the terminal cover away from the base. Remove timer module by pulling straight out.



Place screw through 3 mounting holes in base and screw to back panel or wall.

Wire in accordance with instructions. Replace terminal cover and push timer firmly onto base. Now replace housing and secure with screws.

NOTE: The Digi 42A is also suitable for DIN rail mounting. Break out housing part that fits over rail on each side.

PANEL MOUNTING—Digi 42E

Cut a square hole 2-5/8" x 2-5/8" (66mm x 66mm) in the front of the panel. Insert the time switch through the opening. With a screwdriver, press down and turn outer screws (A) until flanges are in position to fasten the unit in front panel, then release.

Insert plugs into holes (B).

Use 1/4" quick connects and make connections in accordance with the wiring diagram shown and applicable code requirements.

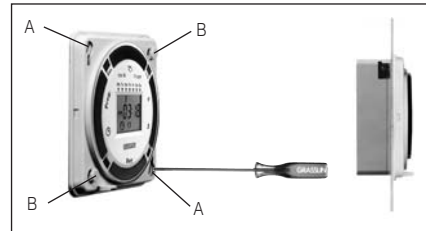

Terminal Connections

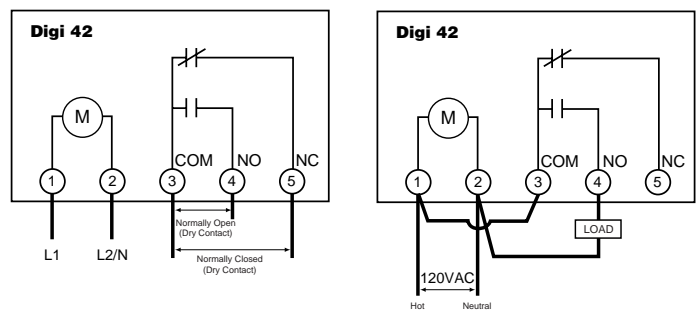

Typical Wiring (120VAC Application)

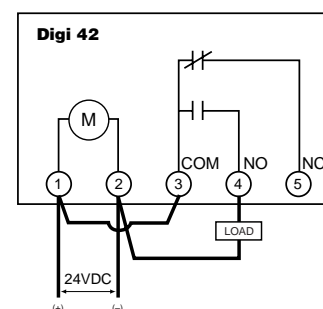

Typical Wiring (24VDC Application)





■ KEYPAD DESCRIPTION

-  Setting the Time/Automatic Run Mode
- Prog.** Program Mode
- Res.*** Reset: Clears all programs and time
-  Select ON or OFF in Prog. Mode, Manual Override Run Mode
- ±1h*** Manual Daylight Change Key
- h** Setting the Hour (12:-- AM)
- m** Setting the Minute (12:01 AM)
- Day** Set Day and Select Days to be Omitted
- Sel.** Omit Day Selected w/Day key
-  Holiday Key

*Recessed keys; use a pen point to press

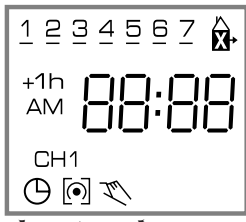

■ LCD DISPLAY ELEMENTS













Days of the Week → 1 2 3 4 5 6 7  ← Holiday Indicator

Daylight Time Symbol → +1h
AM and PM Symbol → AM ← Time of Day or Switching Time

Channel Indication → CH1

Run Mode Symbol  ON/OFF Symbol  Manual Override ON 

Under normal operation the clock symbol should always appear.

		Auto ON Symbol indicates output is ON based on program. Terminals 3&4 make while 3&5 break.
		Auto OFF Symbol indicates output is OFF based on program. Terminals 3&4 break while 3&5 make.
		Continuous ON Symbol indicates output is permanently ON. Terminals 3&4 make while 3&5 break.
		Continuous OFF Symbol indicates output is permanently OFF. Terminals 3&4 break while 3&5 make.
		Temporary ON Symbol indicates output is temporarily ON. Terminals 3&4 make while 3&5 break. It will resume Auto operation at the next program event.
		Temporary OFF Symbol indicates output is temporarily OFF. Terminals 3&4 break while 3&5 make. It will resume Auto operation at the next program event.

■ PROGRAMS

The Digi 42 will accept up to 42 programs

A program consists of:

1. An ON or OFF command
2. Time of day (Hour and Minute)
3. Single day or multiple days

A program is required for each ON event, and a program is required for each OFF event.

NOTE: MULTIPLE ON OR OFF EVENTS MAY BE PROGRAMMED.

For example, Program 1 may turn the office air conditioner ON at 8AM Mon.-Fri. Program 2 may turn the air conditioner OFF at 5PM Mon.-Fri.

If someone is working late, they may press the override key to turn ON the air conditioner. If they forget to press the override key again when they leave, the air conditioner will stay on all night (or all weekend).

To prevent this from occurring, **additional OFF times may be programmed.**

- Program 3 can turn the air conditioning OFF at 6PM.
- Program 4 can turn the air conditioning OFF at 7PM.
- Program 5 can turn the air conditioning OFF at 8PM., etc.

IMPORTANT: BEFORE PROCEEDING WITH SETTING THE TIME AND PROGRAMMING THE UNIT, PRESS THE RESET.

■ SELECTING AM/PM OR MILITARY TIME

After pressing reset, the display may show AM (right). The numbered day symbols will be flashing on and off.

If the display does not show AM, it is in military time mode (24:00 hr.) To change to AM/PM mode, press and hold the **h** key and press the **±1h** key once. AM will appear in display.

If display is in AM mode and military mode is desired, press and hold the **h** key, press the **±1h** key once.





■ SETTING THE TIME

NOTE: If the **h** and **m** keys are held down longer than 2 seconds, the numbers will advance rapidly.

Press and hold the  key during the following:

(If Daylight Savings Time is in effect, press **±1h** first)

1. Press **h** to advance to the current hour (while holding down the  key)
2. Press **m** to advance to the current minute (while holding down the  key)
3. Press **Day** repeatedly to advance to current day (while holding down the  key)

NOTE: If the days are flashing, it indicates the day of the week was not set when setting the time. The timer cannot be programmed unless the day of the week is entered.

■ MANUAL DAYLIGHT TIME CHANGEOVER

Each year, in the Spring, press **±1h** to advance the time an hour. In the Fall, press **±1h** to set back an hour.

■ SETTING AUTOMATIC DAYLIGHT TIME CHANGEOVER (OPTIONAL)

NOTE: It is only necessary to program the changeover dates once. The timer will then automatically change the time at 2:00AM on the first Sunday in April and the last Sunday in October until the year 2079.

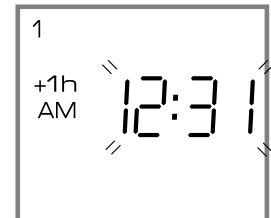

1. Press and hold the **±1h** key and press the **Day** key once. If in AM/PM mode, "12:31" (Dec. 31) will be flashing. If in military time mode, "31:12" will be flashing.
2. Enter the current (today's) date. **Example: June 15, 1997.** Press **m** key (for date) to **15** first and then press **h** key (for month) to **06** (If in military time, h is date and m is month)
3. Press **±1h** once, a **2** under Tu and **1995** appears in display
4. Enter the current year. **Example: 1997.** Press **m** key twice to **1997** (If you overshoot, hold down the m key – the years will scroll to 2079 and back to 1995)
5. Press **±1h** once, a **3** under We and **AU** appears in display, which indicates preset European dates.
6. Press **m** key once so display shows **CHA** (If m key is inadvertently pressed twice and **HA** shows in display, press m key two more times until **CHA** shows)
7. Press **±1h** once, a **4** under Fr and **03:30** (for 1997) appears in display, which indicates March 30 (30:03 in military)
8. Enter the date for spring time change. **Example: April 6, 1997.** Press **h** key (for month) to **04**. Press **m** key (for date) to **06** (If in military time, h is date and m is month)
9. Press **±1h** once, a **5** under Sa and the fall time change date appears in display. **Example: 10:26 for 1997**
10. Press  key to enter Run Mode

Daylight Time Changeover Dates

1997 April 6 - October 26	2002 April 7 - October 27
1998 April 5 - October 25	2003 April 6 - October 26
1999 April 4 - October 31	2004 April 4 - October 31
2000 April 2 - October 29	2005 April 3 - October 30
2001 April 1 - October 28	2006 April 2 - October 29

PROGRAMMING 24 HOUR OR 7 DAY SCHEDULES

It is helpful to write out the program schedules *before* beginning. See last page.

IMPORTANT: THE CURRENT TIME OF DAY AND DAY OF WEEK MUST BE SET PRIOR TO PROGRAMMING. SEE "SETTING THE TIME"

NOTE: The **Day** and **Sel.** keys are used to *omit* days of the week for which the OFF or ON time is not to be implemented. For 24 hour schedules (same program *every* day for the week), ignore **Day** and **Sel.** keys.

If an ON or OFF symbol is not entered, the ON symbol will flash, and program will not be accepted.

Example

Program 1: ON at 7:00AM Monday thru Friday

Program 2: OFF at 6:00PM Monday and Friday only

Program 3: OFF at 5:00PM Tuesday, Wednesday and Thursday

Three programs need to be entered.

Press **Prog.** key only once. Display shows:

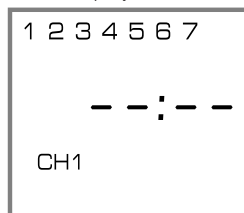

Program 1 (ON at 7:00AM Monday thru Friday)

- | | |
|------------------------------------|-------------------------------|
| Press ON key once | ON symbol appears |
| Press h key | to 07AM |
| Press m key once | to 00 |
| Press Day key 6 times | flashing line appears under 6 |
| Press Sel. key once to omit | 6 in display flashes |
| Press Day key once | flashing line appears under 7 |
| Press Sel. key once to omit | 7 in display flashes |
| Press Prog. key to enter | |

Program 2 (OFF at 6:00PM Monday and Friday)

- | | |
|---|-------------------------------|
| Press OFF key twice | OFF symbol appears |
| Press h key | to 06PM |
| Press m key once | to 00 |
| Press Day key twice | flashing line appears under 2 |
| Press Sel. key once to omit | 2 in display flashes |
| Press Day key once | flashing line appears under 3 |
| Press Sel. key once to omit | 3 in display flashes |
| Repeat Day and Sel. keys for days 4, 6, and 7 | |
| Press Prog. key to enter | |

Program 3 (OFF at 5:00PM Tuesday, Wednesday and Thursday)

- | | |
|---|-------------------------------|
| Press OFF key twice | OFF symbol appears |
| Press h key | to 05PM |
| Press m key once | to 00 |
| Press Day key once | flashing line appears under 1 |
| Press Sel. key once to omit | 1 in display flashes |
| Press Day key 4 times | flashing line appears under 5 |
| Press Sel. key once to omit | 5 in display flashes |
| Repeat Day and Sel. keys for days 6 and 7 | |
| Press Prog. key to enter | |
| Press Run key to enter Run Mode | |

IMPORTANT: IF AN "ON" TIME WAS PROGRAMMED THAT IS EARLIER IN THE DAY THAN THE CURRENT TIME, PRESS **ON** ONCE TO TURN THE TIMER "ON". (IT DOES NOT "LOOK BACK" TO DETERMINE IF IT SHOULD BE ON OR OFF AFTER PROGRAMMING)

MANUAL OVERRIDE

TEMPORARY: While in the Run Mode, pressing the **ON** key once will reverse the output; ON to OFF or OFF to ON. The **ON** symbol appears in the display to indicate a temporary override. At the next scheduled switching time, automatic control resumes, eliminating the override.

CONTINUOUS: While in the Run Mode...

- Pressing the **ON** key twice will turn the output to ON permanently. symbol appears in display.
- Pressing the **OFF** key three times will turn the output OFF permanently. symbol appears in display.
- To terminate a continuous override, press the **ON** key until appears in the display.

REVIEWING PROGRAMS

To review the programs at any time, press **Prog.** key. Programs will appear in the order they were entered with repeated presses of the **Prog.** key. After all programs have been reviewed, the blank display will appear to allow entering another program. Another press of the **Prog.** key will display the number of free programs available, such as **Fr 38** if 4 programs have been entered.

CHANGING A PROGRAM

Select the program to be changed with the **Prog.** key. New days may be omitted or omitted days may be returned by using the **Day** and **Sel.** keys just as in initial programming. Hour and minute can be changed with the **h** and **m** keys.

Press **Prog.** key to store the new program.

DELETING A PROGRAM

Press **Prog.** key until the desired program is displayed.

Press **m** key to **:59** and press once more to blank out.

Press **h** key to **11PM** and press once more to blank out.

Press **Run** key, display will flash for several seconds and then enter the Run Mode.

Using the reset key will delete ALL programs, the time of day, and daylight change dates.

HOLIDAY PROGRAM

An "8th day", or Holiday program schedule may be entered for use on holidays or vacation periods. More than one ON or OFF time may be entered for the Holiday program.

A typical Holiday schedule may be to turn OFF at 12:01AM during the holiday period.

- Press **Prog.** key to first free program
- Press **OFF** key twice;
OFF symbol appears
- Press **h** key once to 12AM
- Press **m** key twice to 01
- Press **ON** key once

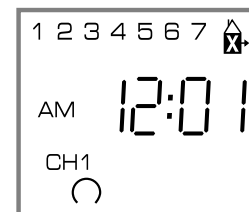

Enter additional ON or OFF schedules as above, followed by the **ON** key.

■ IMPLEMENTING HOLIDAY PROGRAM

Up to 6 days in advance of the Holiday, the "8th day" or Holiday schedule may be selected to begin on a certain day of the week, and continue from 1 to 99 days.

Example: Thursday and Friday will be Holidays

1. Press key once
2. Press **Day** key to 4 (Th)
3. Press **Sel.** key twice to 02

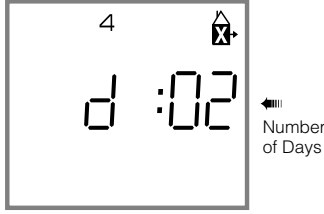
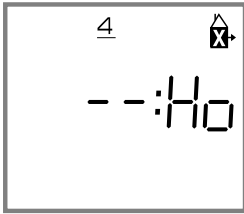

4. Press key to enter Run Mode

Display will show symbol above current time

8th day schedule will be implemented on Thursday and run for 2 days and then timer will revert back to normal programs.

NOTE: If **Sel.** key is held down, it will scroll rapidly to 99 and back to 01

To review the implementation scheduled, press key once. Display shows day of implementation and number of days holiday program will be active. Press key.

To delete the implementation scheduled, press key twice. symbol disappears from display.

On the day the Holiday Program is selected to begin, the 8th day program will be implemented. The display will show the Holiday symbol and number of days remaining in the holiday period. To cancel at this point, press once.

■ TROUBLESHOOTING

PROBLEM: Days are flashing, pressing any key does nothing except key turns output ON and OFF.

SOLUTION: **Time of Day** and **Day of Week** have not been set. See "SETTING THE TIME"

NOTE: This is the condition after a reset. If the timer is found in this condition after it has been installed, programmed and operating for a while, it may indicate that electrical noise or voltage transients have disrupted the microprocessor causing a loss of program information. Call 1-800-272-1115 and request that a no-charge "Snubber Filter" be sent to you to place across the input to the timer, which may solve the problem.

A second, but very unlikely cause of loss of program is a power failure with the backup battery low or dead. Check by disconnecting power and monitoring how long the battery keeps the time of day in the display.

PROBLEM: Time of day was set while holding the key down, but days are still flashing.

SOLUTION: Current day of week was not set **while holding down the key**. See "SETTING THE TIME"

PROBLEM: It is 10AM and a ON program for 8AM was entered, but the output is not ON. Display shows the and symbols.

SOLUTION: After programming, the timer does not "look back" to determine if it should be ON. Press the key (temporary override) to turn the output ON; appears in display. The timer will resume automatic operation at the next programmed event.

PROBLEM: A program for 8AM Monday thru Friday was entered, but it will not accept it and CH1 is flashing.

SOLUTION: The ON or OFF was not entered as part of the program. ON or OFF **must be selected**.

■ TESTING UNIT

After the unit has been programmed you may want to check if it will perform ON/OFF switching at the correct times. To accomplish this test simply change the current time to 1 minute before the actual programmed switching event time. For example if the ON time programmed is at 8:00AM (MON-SUN) and the OFF time programmed is at 5:00PM (MON-SUN) then first check the ON event by changing the current time to 7:59AM. The unit will display as follows (see setting the time section):

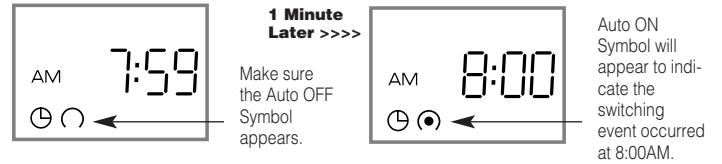

To check the OFF event change the current time to 4:59PM. The unit will display as follows (see setting the time section):

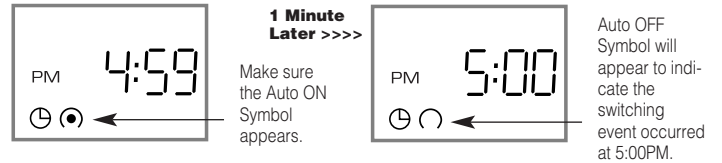

This process verifies that the unit will switch at the proper programmed times. Now simply change the time to the actual current time.

Digi 42 Program Schedules

Prog	CH1 ON/OFF	h	m	Day(s)	Holiday Program
1	On	7 am	30	Mon., Tue., Wed., Thurs, Fri.	No